

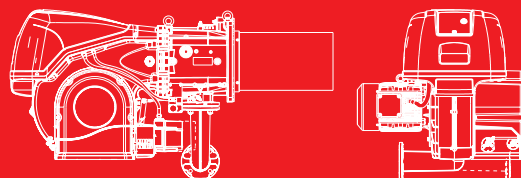

# RS 310-610/E-/EV MZ Series

Modulating Gas Burners

RS 310/E-/EV MZ	600/1200	-	3900	kW
RS 410/E-/EV MZ	800/2000	-	4900	kW
RS 510/E-/EV MZ	802/2200	-	5250	kW
RS 610/E-/EV MZ	820/2400	-	6300	kW



The RS 310-410-510-610/E-/EV MZ burners series covers a firing range from 1200 to 6250 kW, and it has been designed for use in low or medium temperature hot water boilers, hot air or steam boilers, diathermic oil boilers. It is based on the Digital Burner Management System, Riello REC27-37, which is able to manage the air-fuel ratio by independent servomotors in order to obtain a perfect output control and to assure a correct combustion and safe operation on all modulation range. Operation can be "two stage progressive" or, alternatively, "modulating" with the installation of a PID logic regulator and respective probes.

RS/E-/EV MZ burners series guarantees high efficiency levels in all the various applications, thus reducing fuel consumption and running costs; specific versions are available to operate with Variable Speed Drive technology base on the control of a Frequency Inverter that modifies the air flow through the motor speed variation.

The combustion head engineered with advanced simulation devices, guarantees reduced polluting emissions. The exclusive design ensures reduced dimensions, simple use and maintenance.

A wide range of accessories guarantees elevated working flexibility.

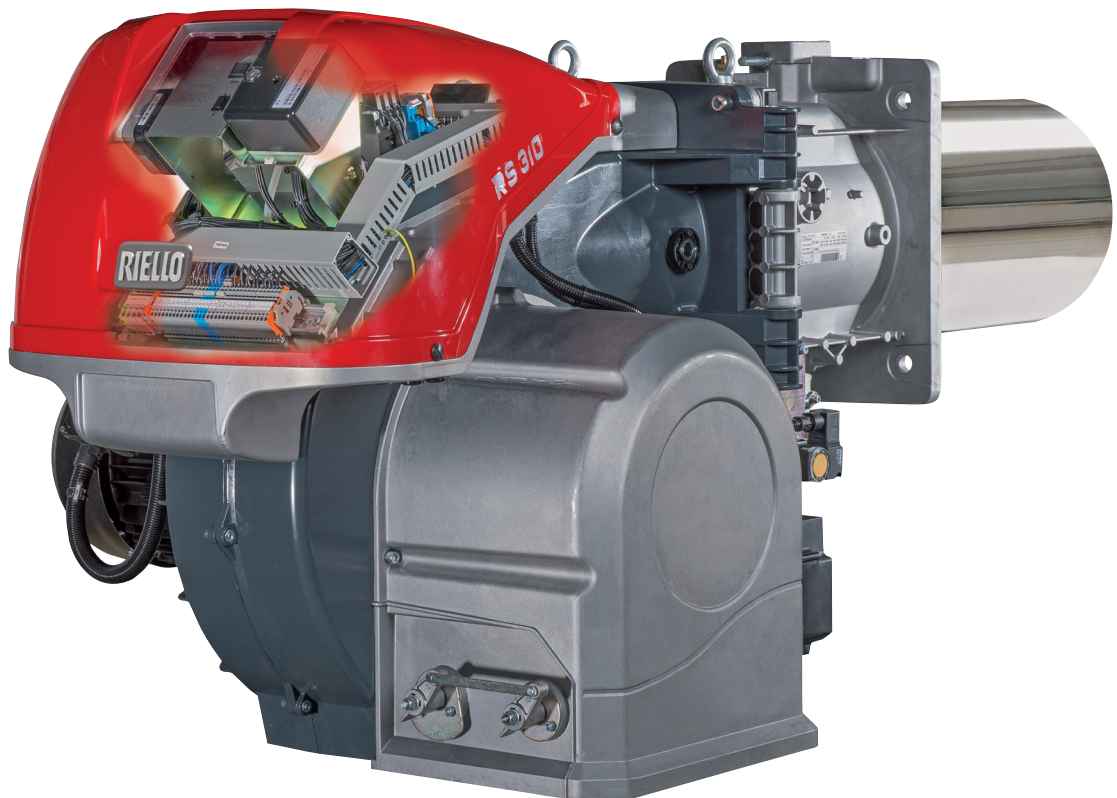

## Technical Data

MODEL		RS 310/E-/EV MZ	RS 410/E-/EV MZ
Burner operation mode		Modulating	
Modulation ratio at max. output		5 ÷ 1	
Servomotor	type	SQM 33 (FS1 - FS2 version)	
Heat output	kW	600/1300÷3900	800/2000 ÷4900
	Mcal/h	516/1118÷3354	688/1720÷4214
Gas pressure at max. output (G20-G25)	mbar	33.2/49.5	41.6/6.2
Working temperature	°C min./max.	0/50	
Fan	type	Forward curve blades	
<b>ELECTRICAL DATA</b>			
Start up	Type	Direct (/E) - Inverter (/EV)	
Electrical supply	Ph/ V/Hz	3N ~ 230 - 400V ±10% 50 Hz	
Total electrical power	kW Max	9.1	10.8
Motor electrical power	kW	7.5	9.2
	A	23.9 - 13.8	29.3 - 16.9
Start up	Type	Star - Delta (/E)	
Electrical supply	Ph/Hz/V	3N ~ 400 - 690V ±10% 50 Hz	
Total electrical power	kW Max	9.1	10.8
Motor electrical power	kW	7.5	9.2
	A	13.8 - 8	16.9 - 9.7
Ignition transformer	V1 - V2	230 V - 1 x 8 kV	
	I1 - I2	1 A - 20 mA	
Control box	type	REC27 (/E models) - REC37 (/EV models)	
Motor protection level	IP	54	
Operation		FS1 - Intermittent (at least one stop every 24 h) FS2 - Continuous (at least one stop every 72 h)	
<b>EMISSIONS</b>			
Sound pressure	dB(A)	78	80
Sound power	dB(A)	89	91
CO emission	mg/kWh	< 10	
NOx emission	mg/kWh	< 120	
<b>APPROVAL</b>			
Directive		2006/42/EC - 2009/142/EC - 2014/30/UE - 2014/35/UE	
Conforming to		EN 676	
Class of emission		2	
Certification		CE-0085C90166 (only for /E models) (The certification for the /EV models is in progress)	

### Reference conditions:

Temperature: 20°C - Pressure: 1013,5 mbar - Altitude: 0 m a.s.l. - Noise measured at a distance of 1 meter. Sound pressure measured in manufacturer's combustion laboratory, with burner operating on test boiler and at maximum rated output. The sound power is measured with the "Free Field" method, as per EN 15036, and according to an "Accuracy: Category 3" measuring accuracy, as set out in EN ISO 3746.

MODEL		RS 510/E-/EV MZ	RS 610/E-/EV MZ
Burner operation mode		Modulating	
Modulation ratio at max. output		5 ÷ 1	
Servomotor	type	SQM 33 (FS1 - FS2 version)	
Heat output	kW	802/2200÷5520	820/2400÷6300
	Mcal/h	689.7/1892÷4747.2	705/2064÷5418
Gas pressure at max. output (G20-G25)	mbar	48.9/73	67/100
Working temperature	°C min./max.	0/50	
Fan	type	Forward curve blades	
<b>ELECTRICAL DATA</b>			
Start up	Type	Star - Delta (/E) - Inverter (/EV)	
Electrical supply	Ph/Hz/V	3N ~ 400 - 690V ±10% 50 Hz	
Total electrical power	kW Max	14	17
Motor electrical power	kW	12	15
	A	21.2 - 12.2	26.7 - 15.4
Ignition transformer	V1 - V2	230 V - 1 x 8 kV	
	I1 - I2	1 A - 20 mA	
Control box	type	REC27 (/E models) - REC37 (/EV models)	
Motor protection level	IP	54	
Operation		FS1 - Intermittent (at least one stop every 24 h) FS2 - Continuous (at least one stop every 72 h)	
<b>EMISSIONS</b>			
Sound pressure	dB(A)	82,5	85
Sound power	dB(A)	93,5	96
CO emission	mg/kWh	< 10	
NOx emission	mg/kWh	< 120	
<b>APPROVAL</b>			
Directive		2006/42/EC - 2009/142/EC - 2014/30/UE - 2014/35/UE	
Conforming to		EN 676	
Class of emission		2	
Certification		CE-0085C90166 (only for /E models) (The certification for the /EV models is in progress)	

## Reference conditions:

Temperature: 20°C - Pressure: 1013,5 mbar - Altitude: 0 m a.s.l. - Noise measured at a distance of 1 meter. Sound pressure measured in manufacturer's combustion laboratory, with burner operating on test boiler and at maximum rated output. The sound power is measured with the "Free Field" method, as per EN 15036, and according to an "Accuracy: Category 3" measuring accuracy, as set out in EN ISO 3746.



# Firing Rate

RS 310-410-510-610/E-/EV MZ

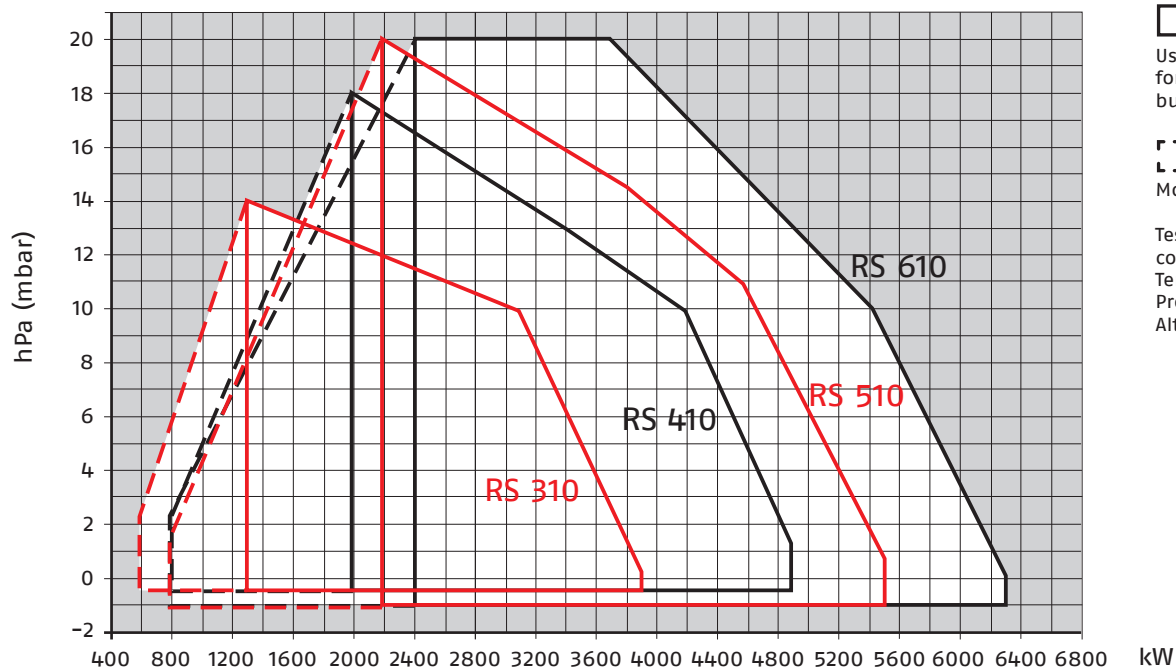

 Useful working field for choosing the burner

 Modulation range

Test conditions conforming to EN676  
 Temperature: 20°C  
 Pressure: 1013,5 mbar  
 Altitude: 0 m a.s.l.

# Gas train

## GAS TRAIN DESIGNATION

Series: MB

MBC
DMV
DMV12
VGD
CB
CBH
MV
CG

Size:	405	407	410	412	415	420							
		65	120	300	700	1200	-	1900	3100	5000			
	505	507	510	512	-	520	525	5065	5080	50100	50125	50150	
	10	15	20	32	40	-	50	-	65	80	100	125	150
		120	220										

Operation:

/S	only ON-OFF function
/1	stage mode opening
/2	2nd stage mode opening
/P	1st stage mode opening with air/gas proportional regulator

Leak detection control:

-	0
CT	leak detection control device installed on the gas train
CQ	equipped with pressure switch for leak detection control

Joint type:

R	threaded joint
F	standard flange ISO
F1	square flange BS1
F2	square flange BS2
F3	square flange BS3 - BS4

Electrical connection:

T	Terminals - Terminal strip
SD	Domestic plug
SM	Medium voltage plug

Standard output pressure range:

-	without pressure governor
0	with governor and air/gas proportional pressure
2	with governor and output pressure up to 20 mbar
3	with governor and output pressure up to 30 mbar
4	with governor and output pressure up to 40 mbar
5	with governor and output pressure up to 50 mbar
6	with governor and output pressure up to 60 mbar
8	with governor and output pressure up to 80 mbar
15	with governor and output pressure up to 150 mbar

Valve control:

0	shared
2	separate

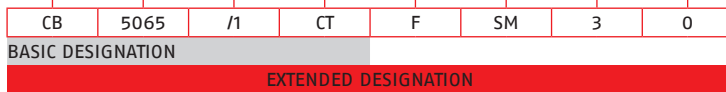

**GAS TRAINS**

The burners are fitted with a butterfly valve to regulate the fuel, controlled by the main management module of burner through a high precision servomotor.  
 Fuel can be supplied either from the right or left sides, on the basis of the application requirements.  
 A maximum gas pressure switch stops the burner in case of excess pressure in the fuel line.  
 The gas train can be selected to best fit system requirements depending on the fuel output and pressure in the supply line.  
 The gas trains are with or without seal control.

**MB "THREADED"**

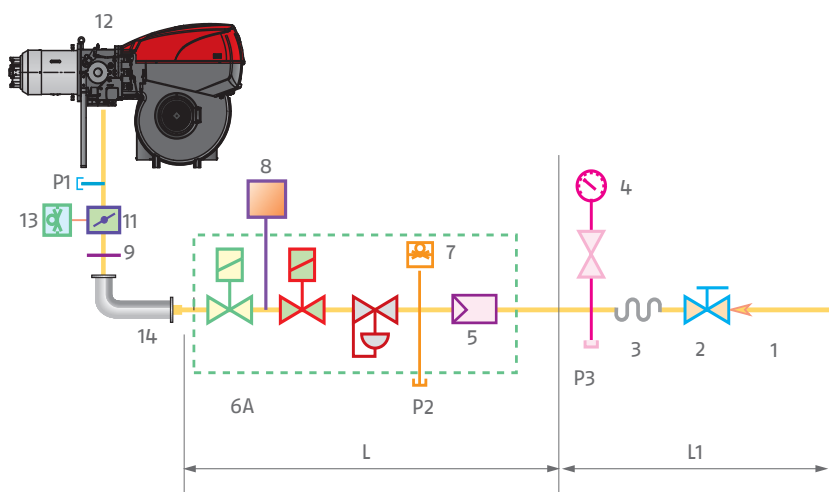

1	Gas input pipework
2	Manual valve
3	Anti-vibration joint
4	Pressure gauge with pushbutton cock
5	Filter
6A	Includes: - filter - operation valve - safety valve - pressure adjuster
7	Minimum gas pressure switch
8	Leak detection device, supplied as an accessory or incorporated, based on the gas train code.
9	Gasket, for "flanged" versions only
10	Pressure adjuster
11	Gas adjuster butterfly valve
12	Burner
13	Maximum gas pressure switch
14	Gas train-burner adaptor, supplied separately
P1	Combustion head pressure
P2	Upstream pressure of valves
P3	Upstream pressure of the filter
L	Gas train supplied separately, with the code given in the table.
L1	Installer's responsibility

**MBC "THREADED"**

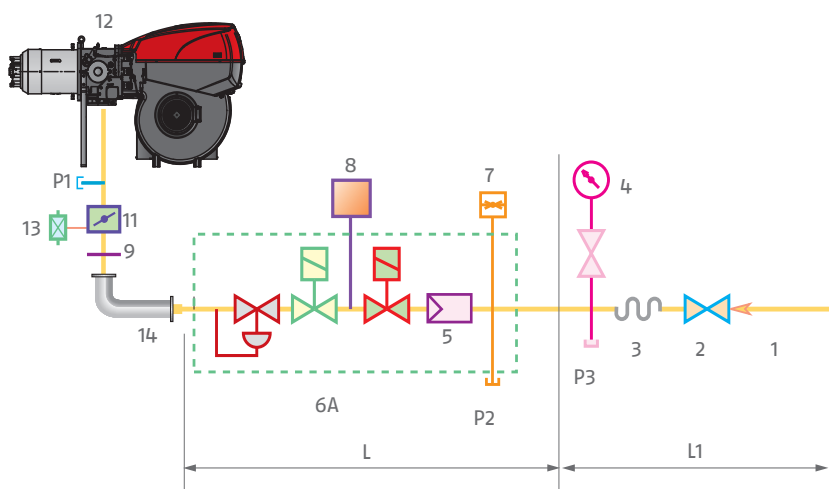

**MBC "FLANGED"**

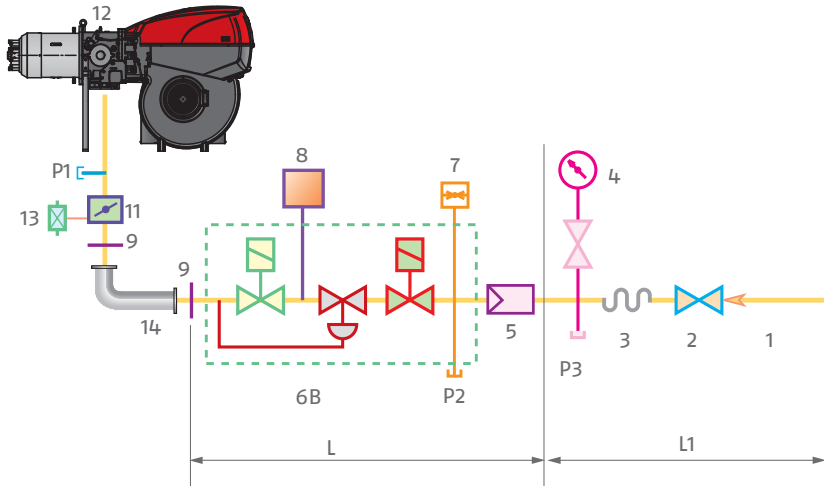

- 1 Gas input pipework
- 2 Manual valve
- 3 Anti-vibration joint
- 4 Pressure gauge with pushbutton cock
- 5 Filter
- 6B Includes:
  - operation valve
  - safety valve
  - pressure adjuster
- 6C Includes:
  - operation valve
  - safety valve
- 6D Includes:
  - operation valve
  - safety valve
- 7 Minimum gas pressure switch
- 8 Leak detection device, supplied as an accessory or incorporated, based on the gas train code.
- 9 Gasket, for "flanged" versions only
- 10 Pressure adjuster
- 11 Gas adjuster butterfly valve
- 12 Burner
- 13 Maximum gas pressure switch
- 14 Gas train-burner adaptor, supplied separately
- P1 Combustion head pressure
- P2 Upstream pressure of valves
- P3 Upstream pressure of the filter
- L Gas train supplied separately, with the code given in the table
- L1 Installer's responsibility

**CB "FLANGED OR THREADED"**

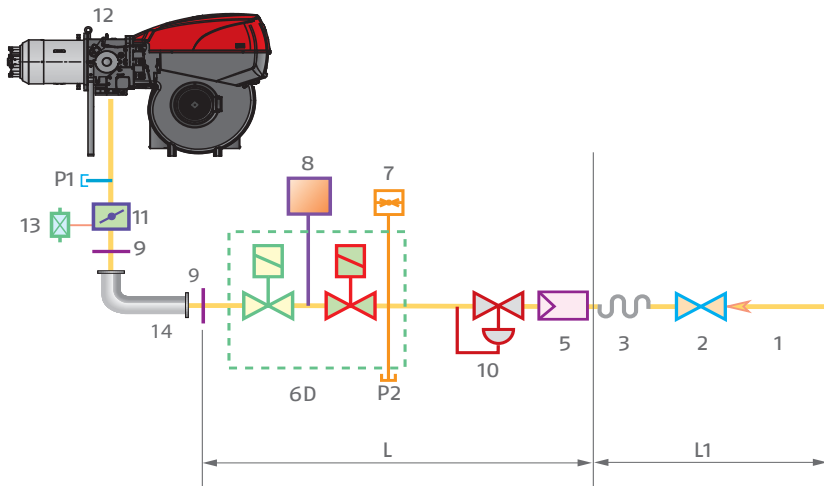

**DMV "FLANGED OR THREADED"**

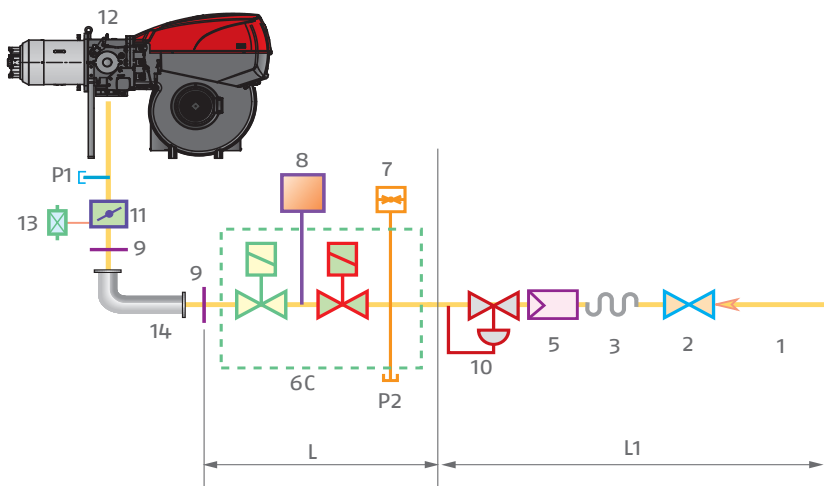

Gas trains are approved by standard EN 676 together with the burner.

The overall dimensions of the gas train depends on how they are constructed. The following table shows the maximum dimensions of the gas trains that can be fitted to RS 310-410-510-610/E-/EV MZ burners, intake and outlet diameters and seal control if fitted.

The maximum gas pressure of gas train "MULTIBLOC" type is 360 mbar, and that one of gas train "COMPOSED" type is 500 mbar.

"MULTIBLOC" guarantees a range of pressure towards the burner from 4 to 60 mbar. For version DN 65 and DN 80 is from 20 to 40 mbar. For version DN 100 is from 40 to 80 mbar. The range of pressure in the "MULTIBLOC" with flange can be modified choosing the stabiliser spring (see gas train accessory).

The maximum gas pressure of gas train "CB" series is 500 mbar. "CB" gas train guarantees a range of pressure towards the burner from 10 to 30 mbar. The range of pressure can be modified choosing the stabilizer spring (see accessories).

The maximum gas pressure of gas train "DMV" series is 500 mbar. "DMV" gas train is supplied without pressure governor.

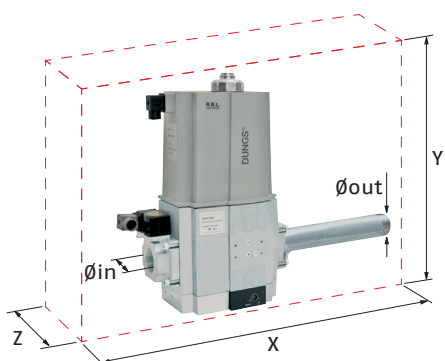

Example of gas train "MULTIBLOC" type without seal control (i.e. MBC 1200)

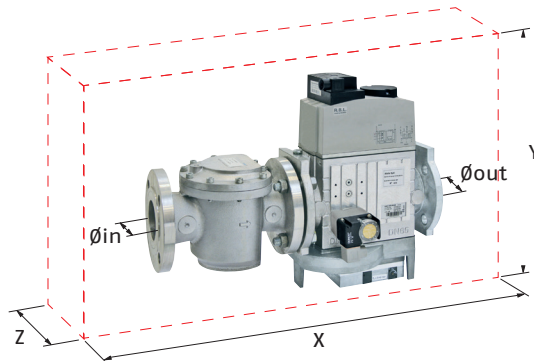

Example of gas train "COMPOSED" type without seal control (i.e. MBC 1900-3100-5000)

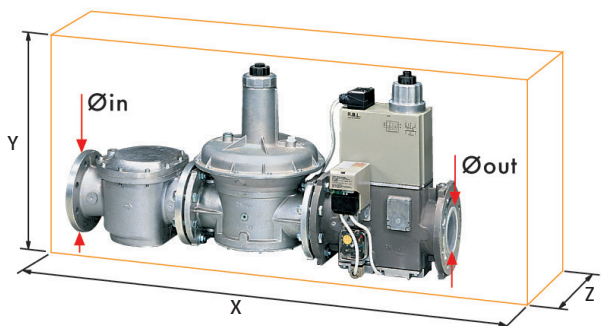

Example of gas train "CB" series with seal control

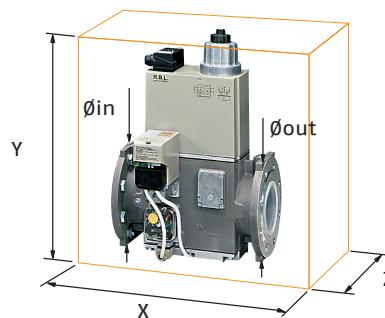

Example of gas train "DMV" series with seal control



GAS TRAIN						
MODEL	CODE	∅ int	∅ est	X mm	Y mm	Z mm
MB 415/1 - RT 52	3970250	Rp 1-1/2"	Rp 1-1/2"	523	250	100
MB 420/1 - RT 52	3970257	Rp 2"	Rp 2"	523	289	100

GAS TRAIN						
MODEL	CODE	∅ int	∅ est	X mm	Y mm	Z mm
MBC 1200/1 - RSM 60	3970221	Rp 2"	Rp 2"	528	424	161
MBC 1900/1 - FSM 40	3970222	DN 65	DN 65	613	430	237
MBC 3100/1 - FSM 40	3970223	DN 80	DN 80	633	500	240
MBC 5000/1 - FSM 80	3970224	DN 100	DN 100	733	576	280

GAS TRAIN						
MODEL	CODE	∅ int	∅ est	X mm	Y mm	Z mm
CB 512/1 - RSM 30	3970145	Rp 1-1/2"	Rp 1-1/2"	891	261	245
CB 520/1 - RSM 30	3970146	Rp 2"	Rp 2"	986	328	255
CB 525/1 - RSM 30	20044659	Rp 2"	Rp 2"	1025	356	285
CB 5065/1 - FSM 30	3970147	DN 65	DN 65	906	356	285
CB 5080/1 - FSM 30	3970148	DN 80	DN 80	934	416	285
CB 50100/1 - FSM 30	3970149	DN 100	DN 100	1054	501	350
CB 50125/1 - FSM 30	20015871	DN 125	DN 125	1164	780	400

GAS TRAIN						
MODEL	CODE	∅ int	∅ est	X mm	Y mm	Z mm
DMV 512/1 - RSM -0	20043035	Rp 1-1/2"	Rp 1-1/2"	490	292	245
DMV 512/1 CQ RSM -2	20043037	Rp 1-1/2"	Rp 1-1/2"	490	292	245
DMV 520/1 - RSM -0	20043038	Rp 2"	Rp 2"	490	292	255
DMV 520/1 CQ RSM -2	20043040	Rp 2"	Rp 2"	490	292	255
DMV 525/1 - RSM -0	20043053	Rp 2"	Rp 2"	530	338	270
DMV 525/1 CQ RSM -2	20043055	Rp 2"	Rp 2"	530	338	270
DMV 5065/1 - FSM -0	20043041	DN 65	DN 65	290	338	270
DMV 5065/1 CQ FSM -2	20043043	DN 65	DN 65	290	338	270
DMV 5080/1 - FSM -0	20043044	DN 80	DN 80	310	397	290
DMV 5080/1 CQ FSM -2	20043046	DN 80	DN 80	310	397	290
DMV 50100/1 - FSM -0	20043047	DN 100	DN 100	350	449	307
DMV 50100/1 CQ FSM -2	20043049	DN 100	DN 100	350	449	307
DMV 50125/1 - FSM -0	20043050	DN 125	DN 125	400	554	333
DMV 50125/1 CQ FSM -2	20043052	DN 125	DN 125	400	554	333

## Pressure Drop Diagram

The diagrams indicate the minimum pressure drop of the burners with the various gas trains that can be matched with them; at the value of these pressure drop add the combustion chamber pressure. The value thus calculated represents the minimum required input pressure to the gas train.

The minimum input gas pressure required is 15 mbar while burner operating. In particular, the pressure difference between gas train upstream and downstream has to remain always over pressure drop values indicated below.

### RS 310/E - /EV MZ (NATURAL GAS)

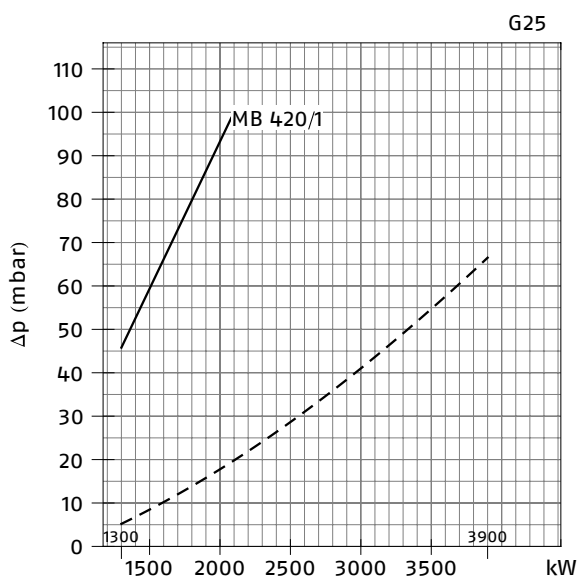
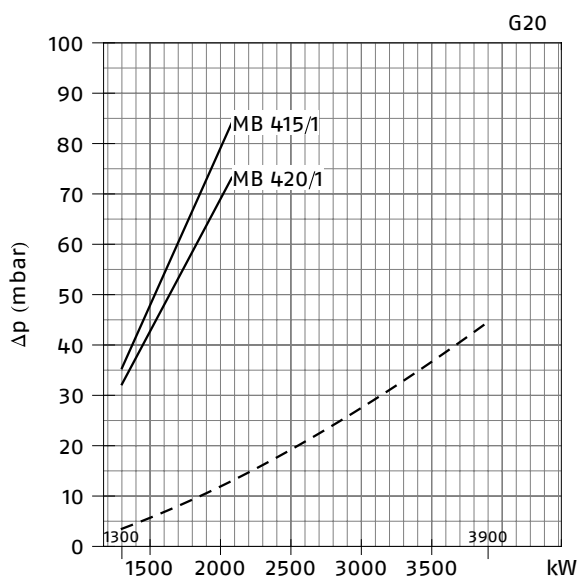

### RS 310/E - /EV MZ (NATURAL GAS)

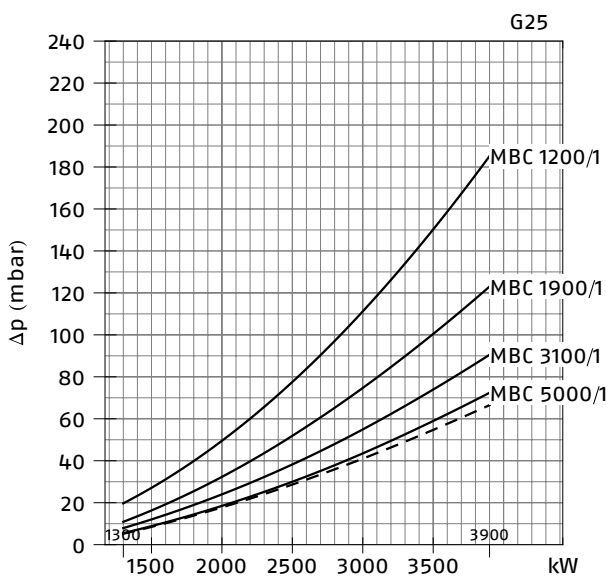
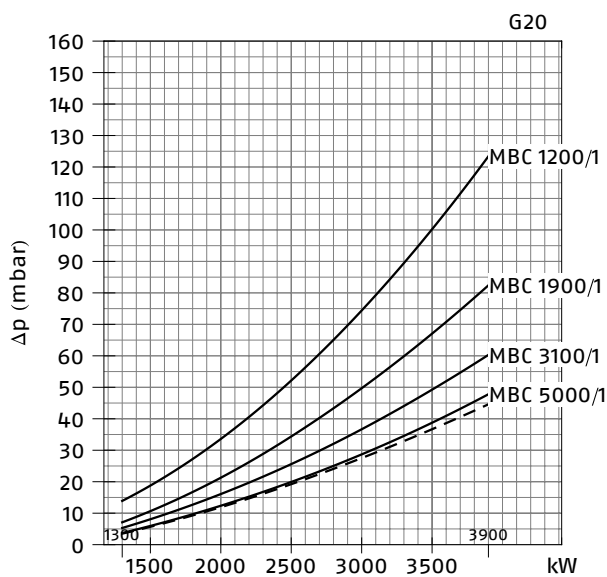

- Combustion head + gas butterfly valve + gas train
- - - Combustion head + gas butterfly valve

RS 310/E - /EV MZ (NATURAL GAS)

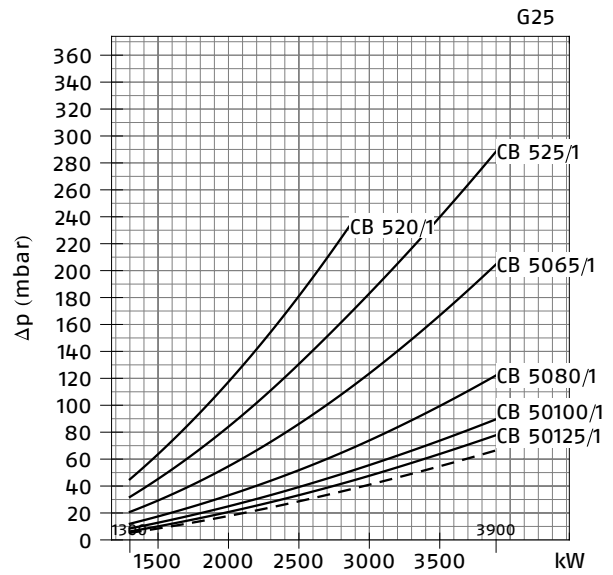
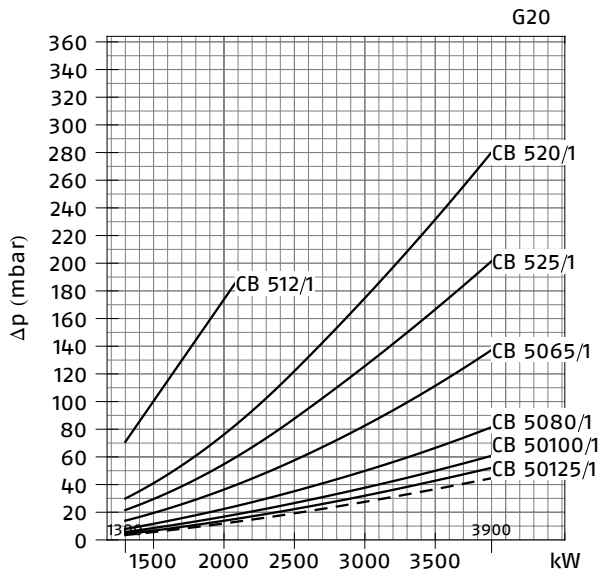

RS 310/E - /EV MZ (NATURAL GAS)

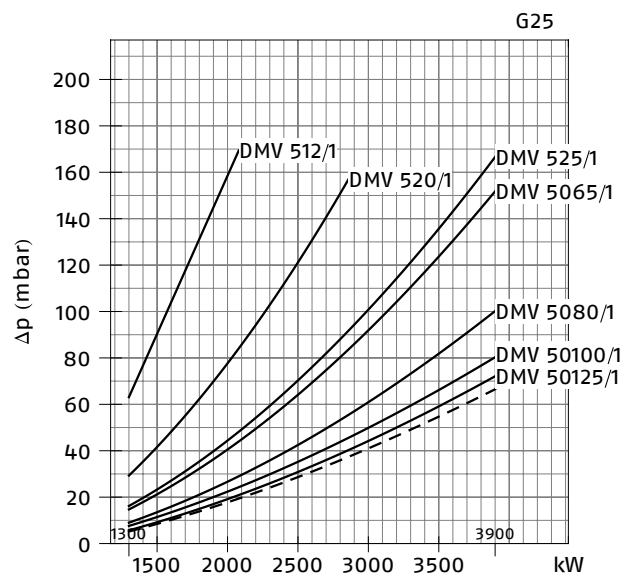
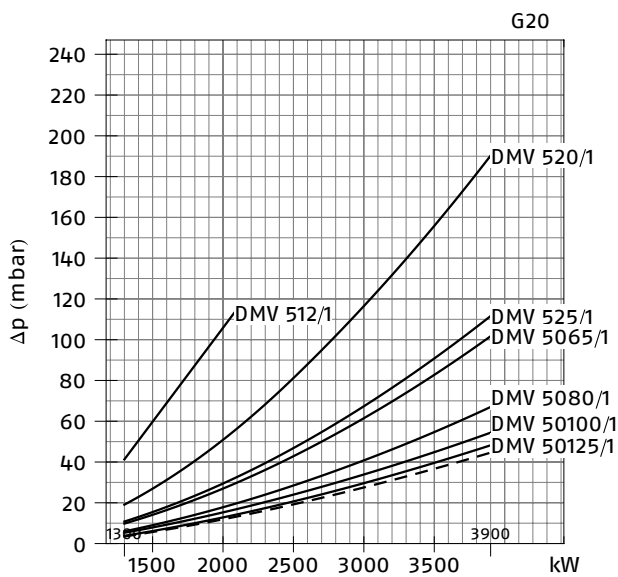

— Combustion head + gas butterfly valve + gas train  
 - - - Combustion head + gas butterfly valve

**RS 410/E - /EV MZ (NATURAL GAS)**

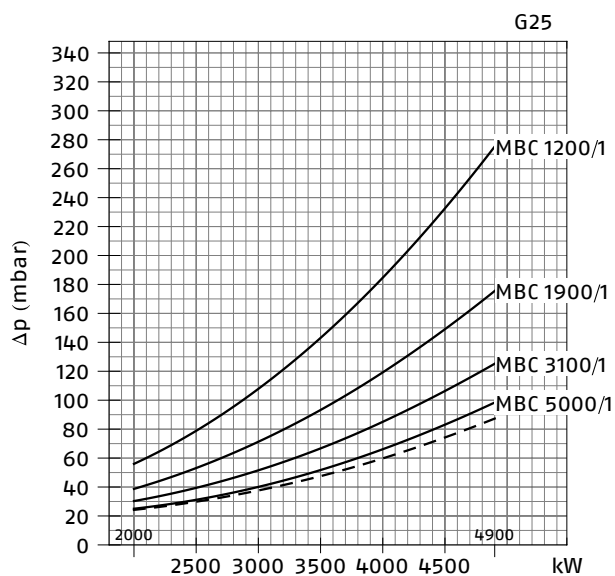
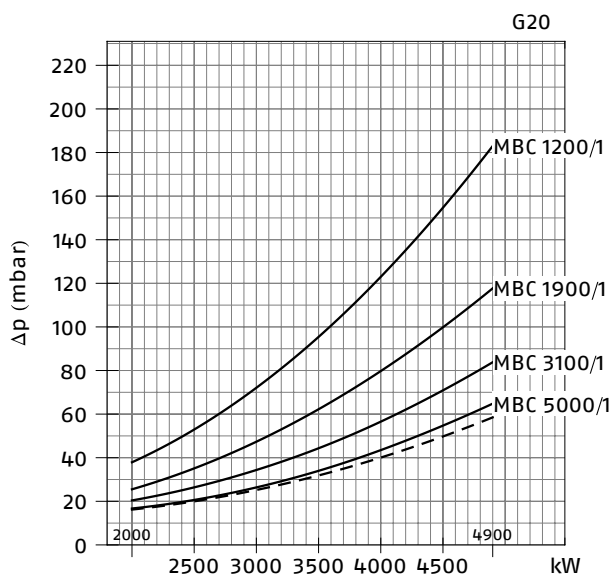

**RS 410/E - /EV MZ (NATURAL GAS)**

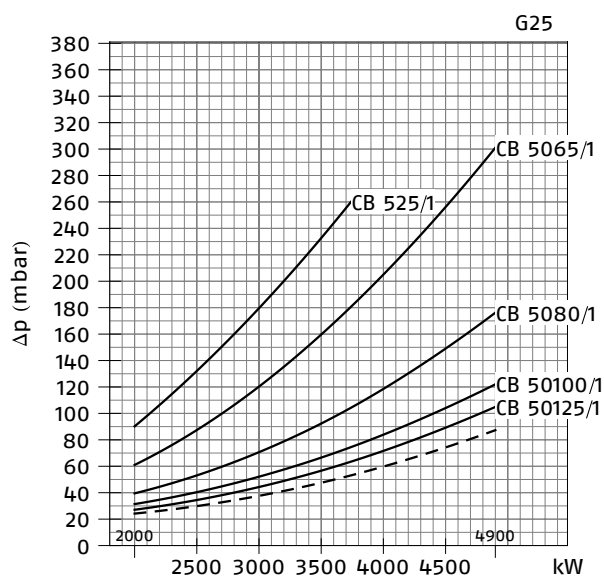
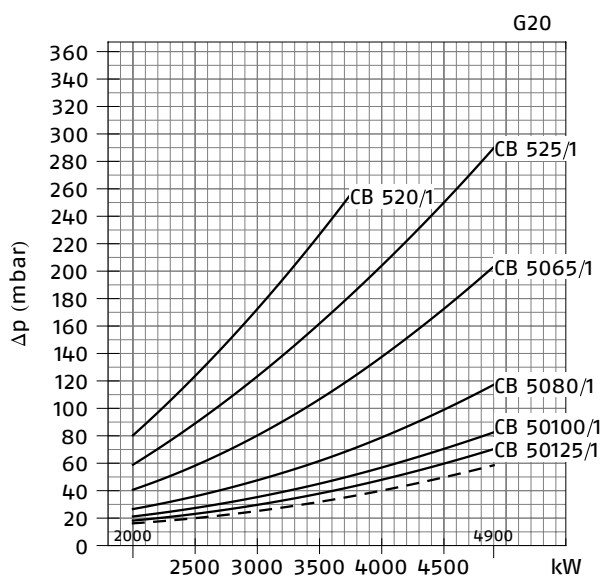

— Combustion head + gas butterfly valve + gas train  
 - - - Combustion head + gas butterfly valve

RS 410/E - /EV MZ (NATURAL GAS)

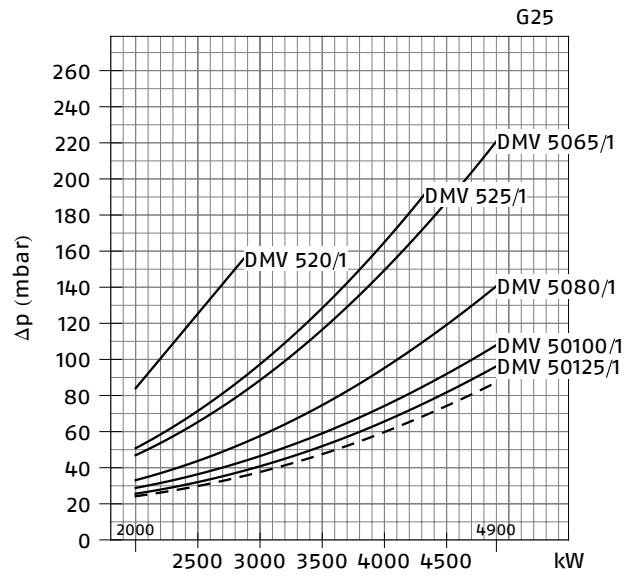
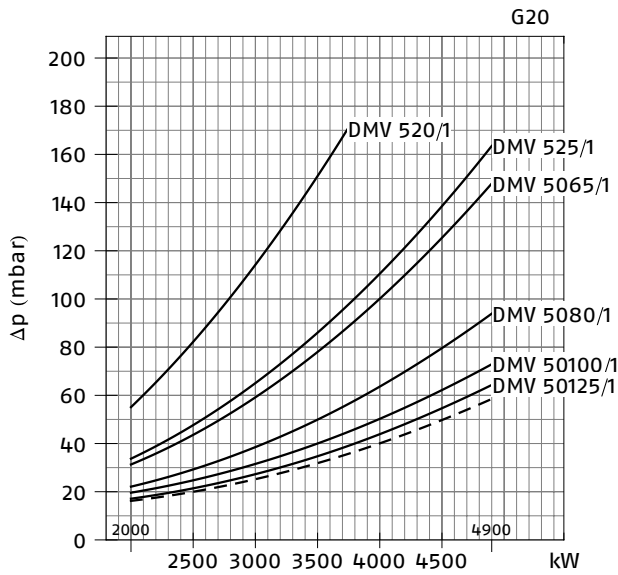

RS 510/E - /EV MZ (NATURAL GAS)

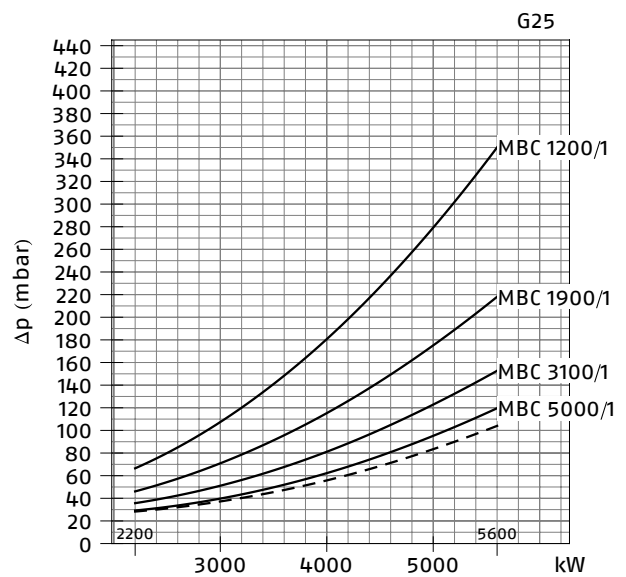
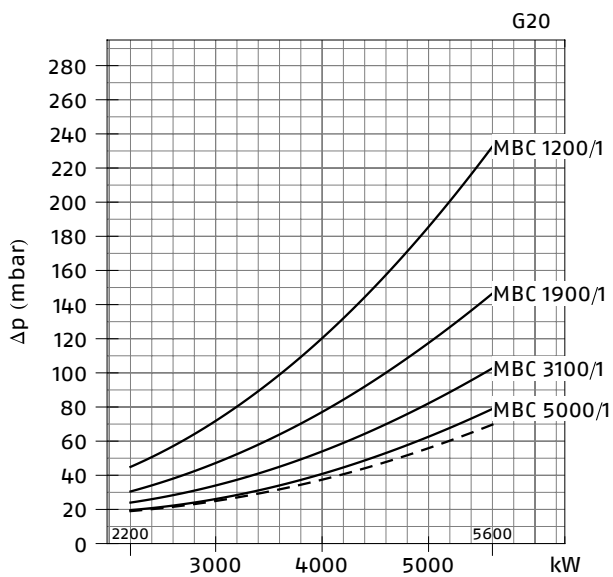

— Combustion head + gas butterfly valve + gas train  
 - - - Combustion head + gas butterfly valve



**RS 510/E - /EV MZ (NATURAL GAS)**

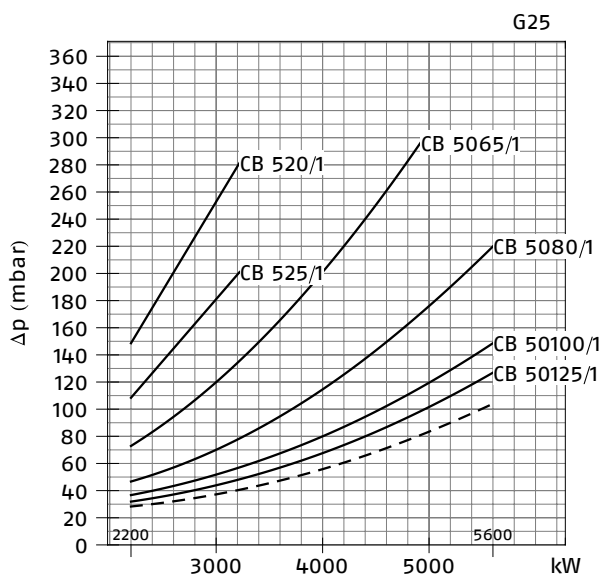
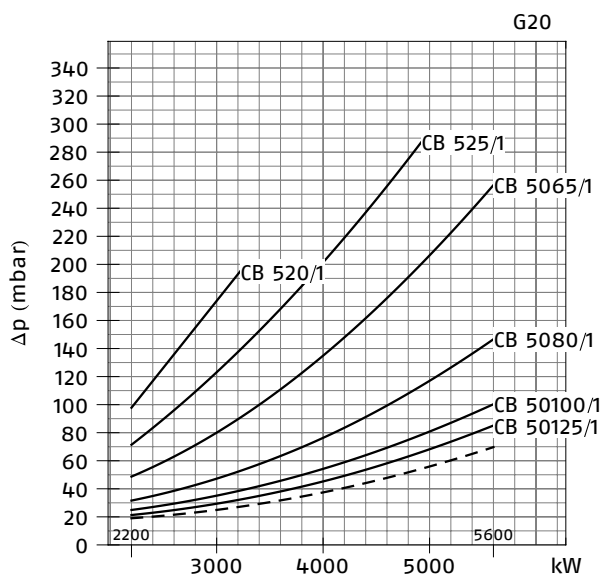

**RS 510/E - /EV MZ (NATURAL GAS)**

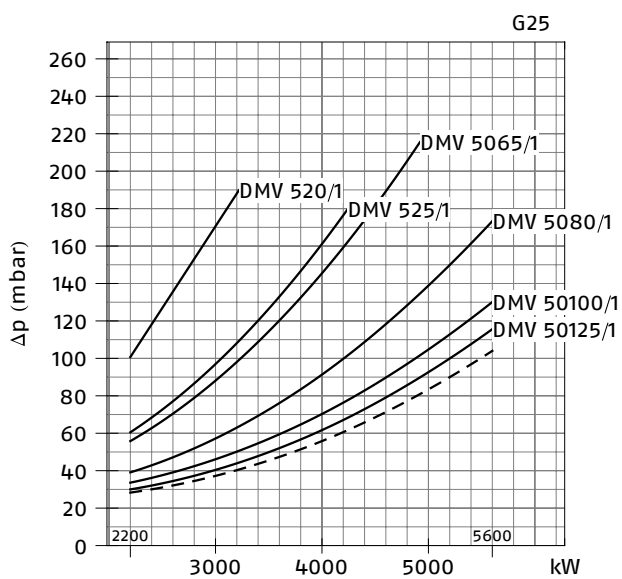
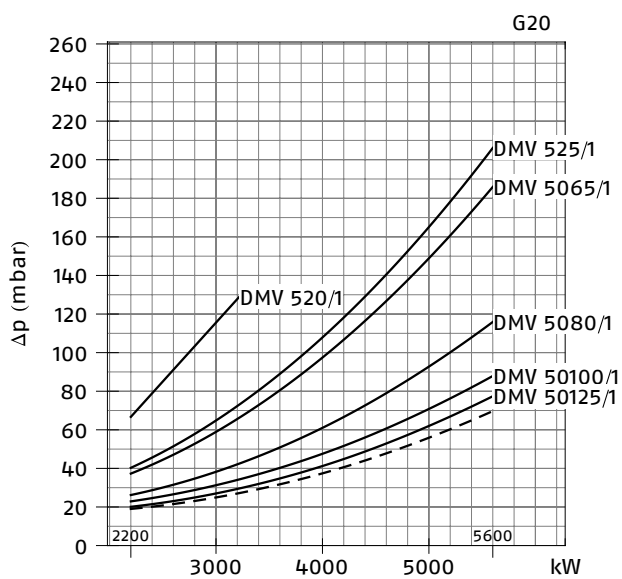

— Combustion head + gas butterfly valve + gas train  
 - - - Combustion head + gas butterfly valve

RS 610/E - /EV MZ (NATURAL GAS)

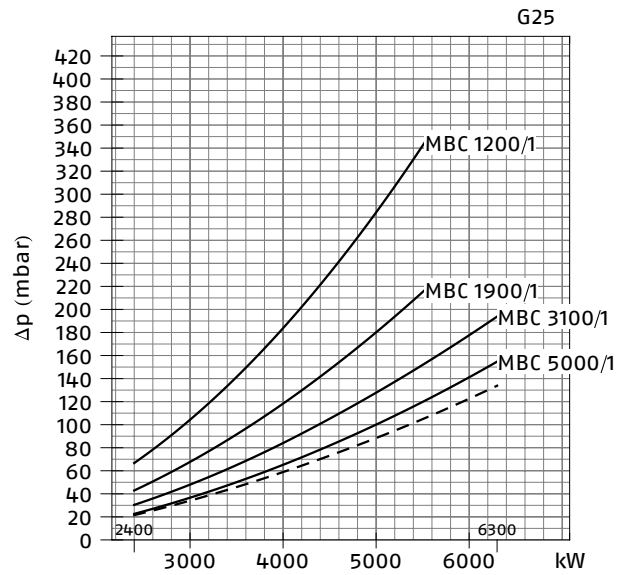
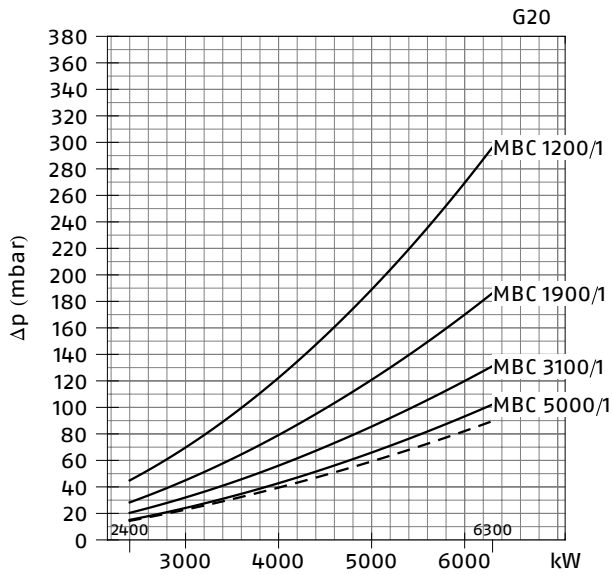

RS 610/E - /EV MZ (NATURAL GAS)

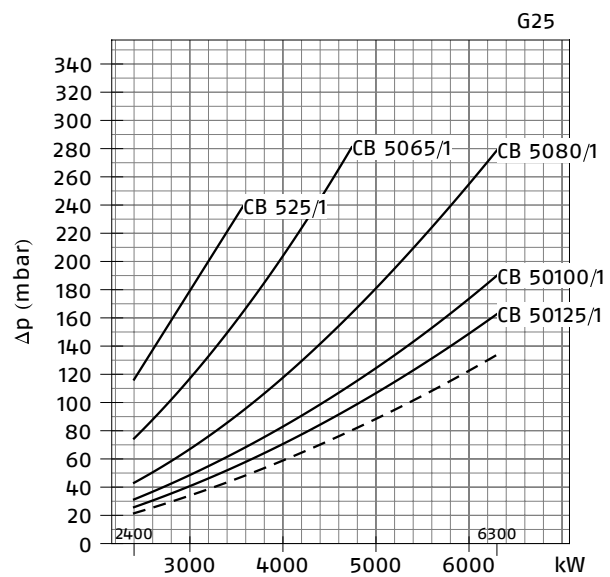
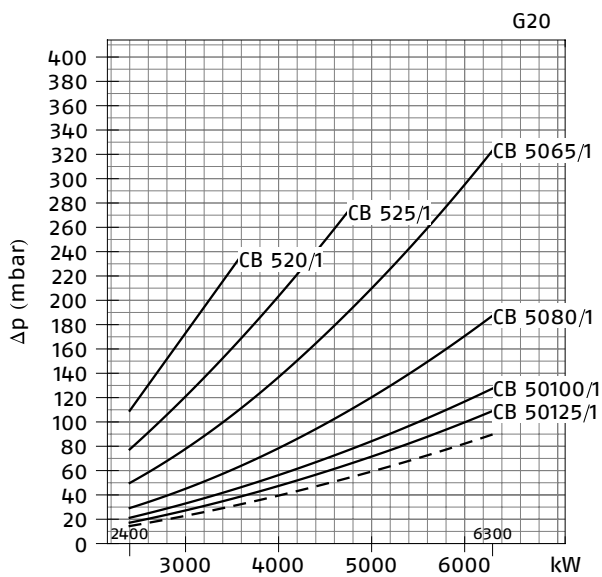

— Combustion head + gas butterfly valve + gas train  
 - - - Combustion head + gas butterfly valve

**RS 610/E - /EV MZ (NATURAL GAS)**

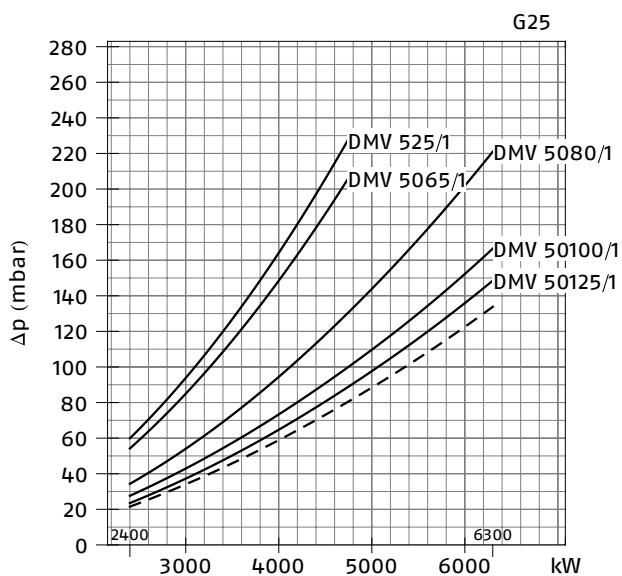
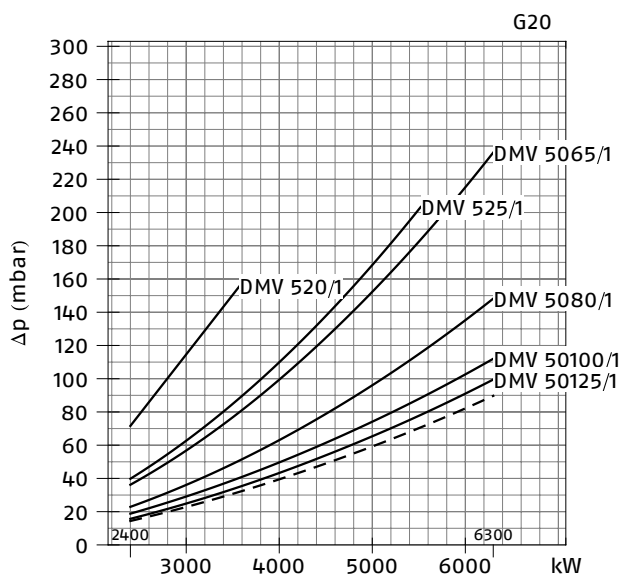

— Combustion head + gas butterfly valve + gas train  
 - - - Combustion head + gas butterfly valve

GAS TRAIN		◆	PVP KIT	ADAPTER			
CODE	MODEL		CODE	CODE			
				RS 310	RS 410	RS 510	RS 610
3970250	MB 415/1 - RT 52	-	3010344	3000826 + 20064220	●	●	●
3970257	MB 420/1 - RT 52	-	3010344	3000826 + 20042324	●	●	●
3970221	MBC 1200/1 - RSM 60	-	3010344	3000826 + 20042324			
3970222	MBC 1900/1 - FSM 40	-	3010344	3010221			
3970223	MBC 3100/1 - FSM 40	-	3010344	3010222			
3970224	MBC 5000/1 - FSM 80	-	3010344	3010222 - 3010370			
3970145	CB 512/1 - RSM 30	-	3010344	3000826 + 20064220	●	●	
3970146	CB 520/1 - RSM 30	-	3010344	3000826 + 20042324			●
20044659	CB 525/1 - RSM 30	-	3010344	3000826 + 20042324			
3970147	CB 5065/1 - FSM 30	-	3010344	3010221			
3970148	CB 5080/1 - FSM 30	-	3010344	3010222			
3970149	CB 50100/1 - FSM 30	-	3010344	3010223 or 3010370			
20015871	CB 50125/1 - FSM 30	-	3010344	3010224			
20043035	DMV 512/1 - RSM -0	-	3010367	3000826 + 20064220	●	●	
20043037	DMV 512/1 CQ RSM -2	CQ	-	3000826 + 20064220	●	●	
20043038	DMV 520/1 - RSM -0	-	3010344	3000826 + 20042324			●
20043040	DMV 520/1 CQ RSM -2	CQ	-	3000826 + 20042324			●
20043053	DMV 525/1 - RSM -0	-	3010344	3000826 + 20042324			
20043055	DMV 525/1 CQ RSM -2	CQ	-	3000826 + 20042324			
20043041	DMV 5065/1 - FSM -0	-	3010344	3010221			
20043043	DMV 5065/1 CQ FSM -2	CQ	-	3010221			
20043044	DMV 5080/1 - FSM -0	-	3010344	3010222			
20043046	DMV 5080/1 CQ FSM -2	CQ	-	3010222			
20043047	DMV 50100/1 - FSM -0	-	3010344	3010223 or 3010370			
20043049	DMV 50100/1 CQ FSM -2	CQ	-	3010223 or 3010370			
20043050	DMV 50125/1 - FSM -0	-	3010344	3010224			
20043052	DMV 50125/1 CQ FSM -2	CQ	-	3010224			

◆ Gas valve leak detection control device (the function of this device is managed by the electronic control box of the burner, through the installation of the pressure switch on the gas train):  
 - gas train not equipped with pressure switch for leak detection control; this pressure switch can be ordered separately - see PVP KIT column - and installed later.

CQ gas train with pressure switch for leak detection control.

PVP KIT Additional pressure switch for leak detection control.

● Gas train not available or not suitable for the matching to the burner.

## Ventilation

The ventilation unit comes with a sound proofing system.

All the burners are fitted with fans, which give excellent performance and are fitted in line with the combustion head. The air flow and sound-deadening materials used in the construction are designed to reduce sound emissions to the minimum and guarantee high levels of performance in terms of output and air pressure.

A high precision servomotor through the main management module installed on each burner, controls the air dampers position constantly.

The RS/EV burners are supplied with the "inverter" technology, which means they are fitted with a device for varying the amount of combustion air through a variable speed action of the fan motor. The burner works at reduced speed, with further benefits in terms of sound emissions, especially during the night when the perception threshold is lower as well decreased power consumption.

### New ventilation structure

A new ventilation structure has been developed in order to reduce the overall dimensions and weight

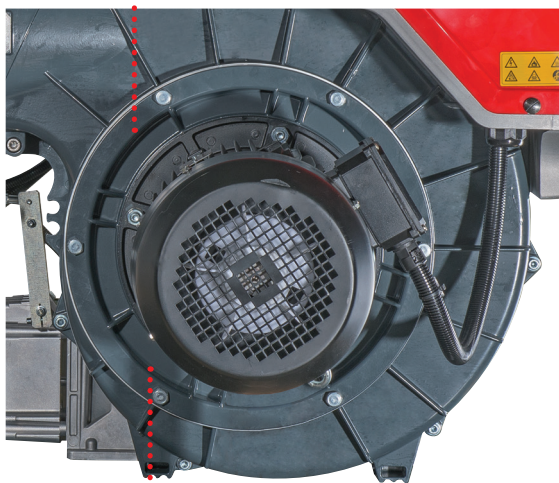

**Simplified Maintenance**  
for motor and fan by direct  
extraction through opening flange



**Air adjusting dampers**  
at air inlet side with ball bearings

## Combustion Head

The combustion head adjustment system allows to adapt internal geometry of the head to the output of the burner. This system guarantees excellent mix on all firing rates range as well as reducing noise and pollutants.

Example of hinged burner opening on the left side of the burner

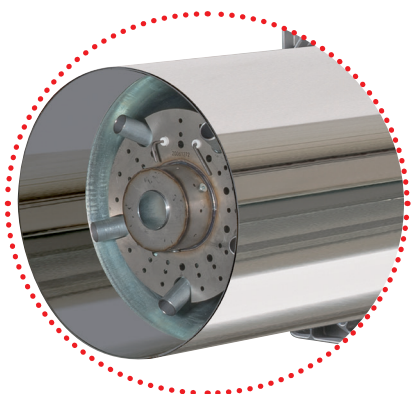

Example of a RS MZ burner combustion head





**SUGGESTED COMBUSTION CHAMBER DIMENSIONS**

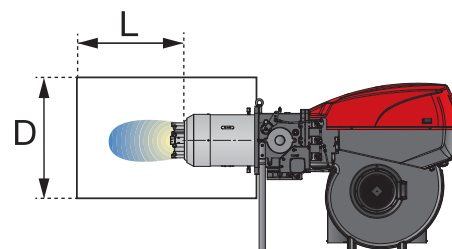
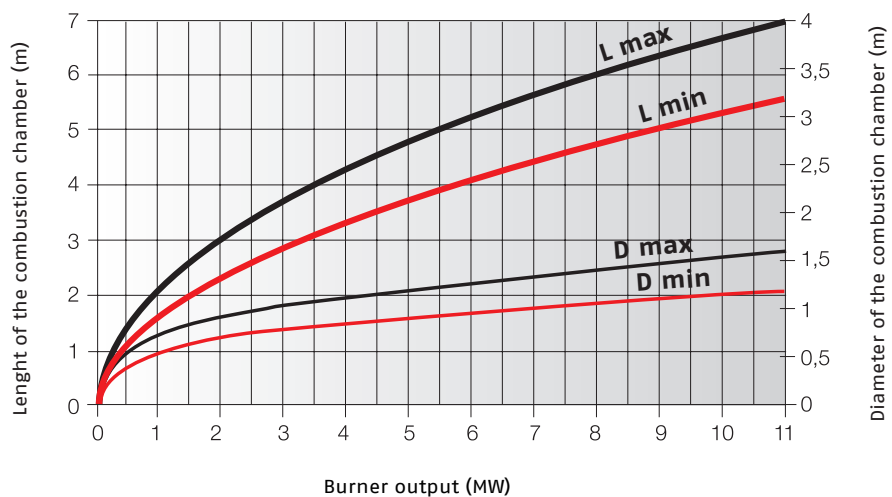

Example:  
 Burner thermal output = 6000 kW;  
 L Combustion Chamber (m) = 4,7 m (medium value);  
 D Combustion Chamber (m) = 1,2 m (medium value)

# Operation

## BURNER OPERATION MODE

The RS 310-410-510-610/E-/EV MZ series of burners can have “two-stage progressive” or “modulating” operation.



Power controller



Analog 4-20 mA or 0 - 10V converter for remote modulation

On “two-stage progressive” operation, the burner gradually adapts the output to the requested level, by varying between two pre-set levels (see picture A).

On “modulating” operation, normally required in steam generators, in superheater boilers or diathermic oil burners, a specific regulator and probes are required. These are supplied as accessories that must be ordered separately. The burner can work for long periods at intermediate output levels (see picture B).

### “TWO-STAGE PROGRESSIVE” OPERATION

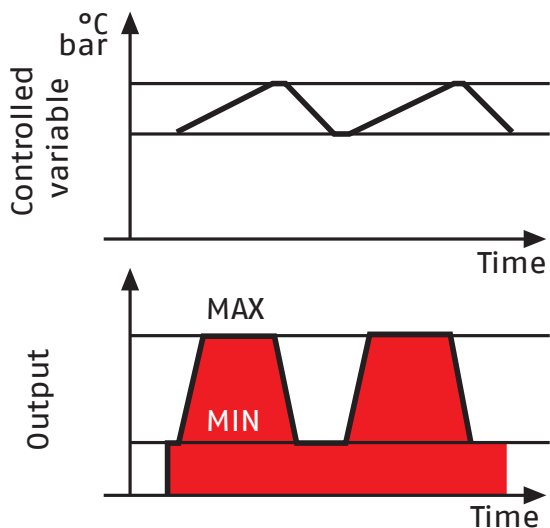

Picture A

### “MODULATING” OPERATION

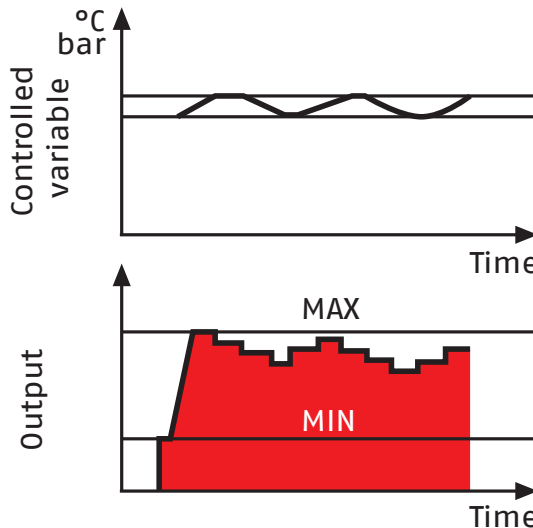

Picture B

**REC27 and REC37  
Digital Burner Management System**

Combustion systems are in continuous evolution and high tech solutions, in particular connected to electronic systems, are today applied in order to obtain better performances and efficiencies. The Burner is one of the most important component of the combustion system and its evolution is in the direction of the perfect control of operation and more efficiency. Following this evolution trend RIELLO RS 310-410-510-610/E-/EV gas burner series has been upgraded with the introduction of new models with modulating operation obtained by Electronic Cam. The new models are based on the Digital Burner Management Systems RIELLO REC27 and REC37, which are able to manage the air-fuel ratio by independent servomotors in order to obtain a perfect output control and to assure a correct combustion and safe operation on all modulation range.

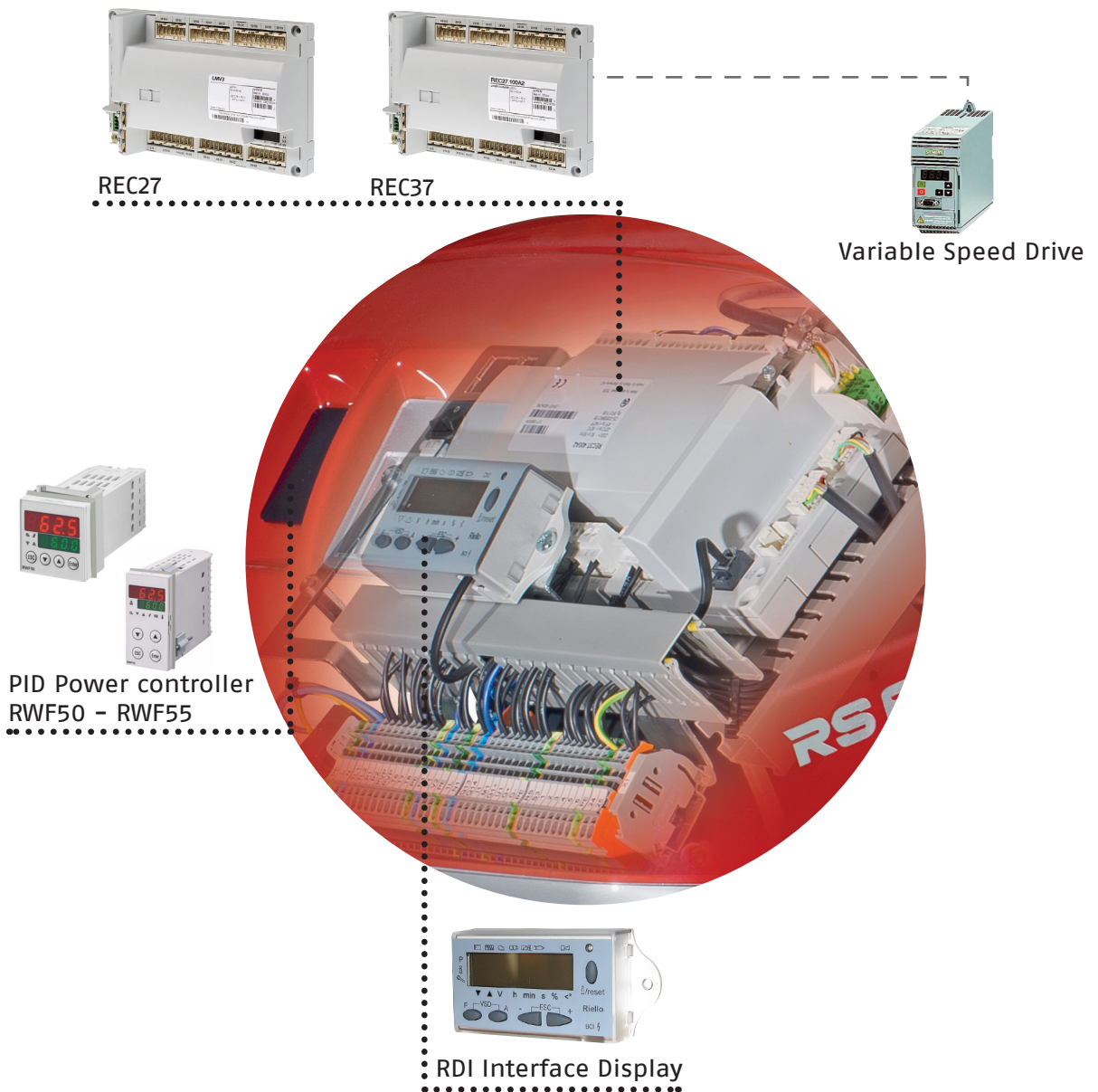

## Emissions

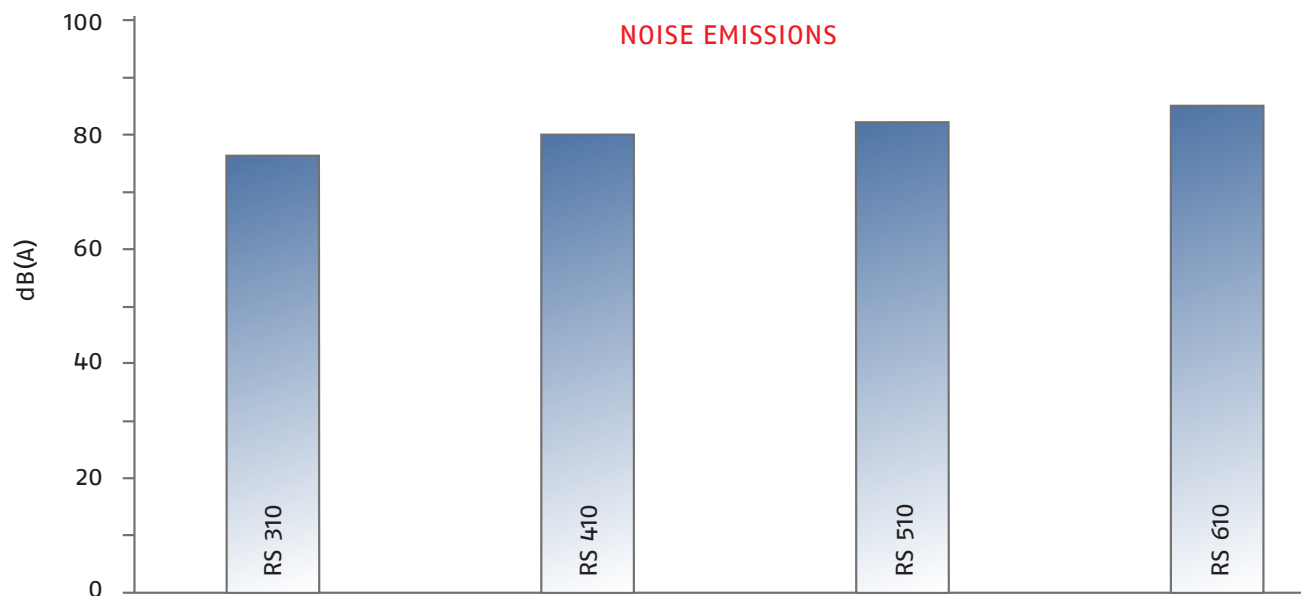

The noise emissions have been measured at the maximum output.

## Overall Dimensions (mm)

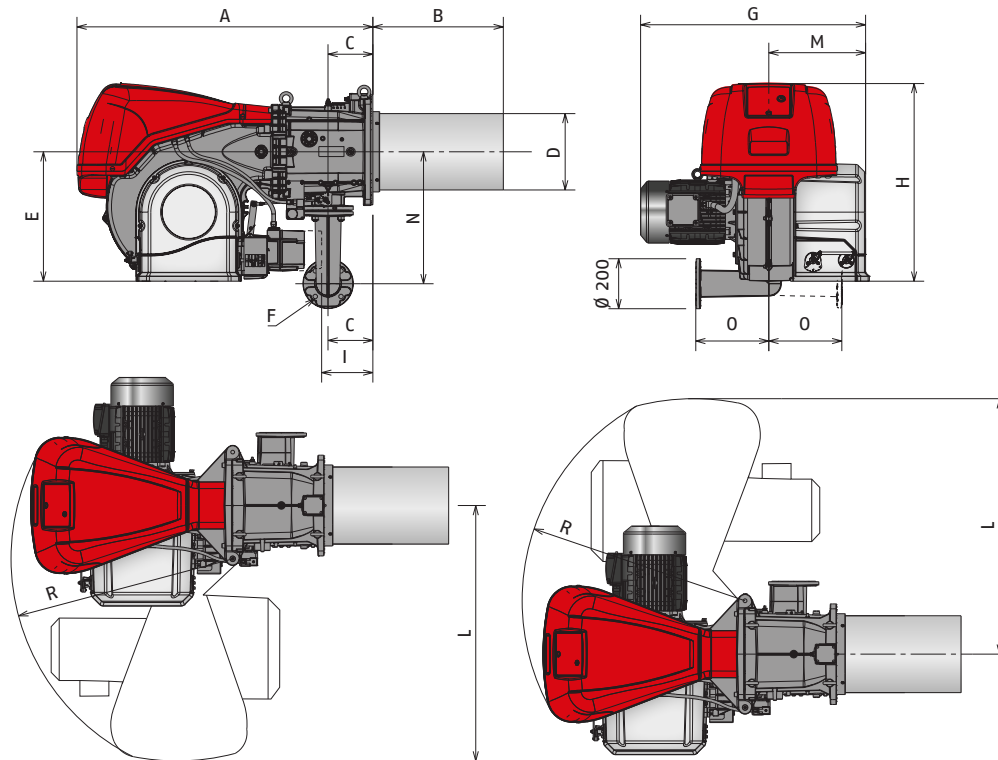

MODEL	A	B	C	D	E	F**	G	H	I*	L	M	N	O	P*	R
RS 310/E-/EV MZ	1178	519	178	306	520	DN65	890	790	177	1015	400	528	290	177	890
RS 410/E-/EV MZ	1178	519	178	306	520	DN65	908	790	177	1015	400	528	290	177	890
RS 510/E-/EV MZ	1178	519	178	306	520	DN65	908	790	177	1015	400	528	290	177	890
RS 610/E-/EV MZ	1178	519	178	330	520	DN65	980	790	177	1015	400	528	290	177	890

\* Maximum position for the extraction of the servomotor cover in mechanical cam models.

\*\* The gas adaptor is set also for DN 80 bore.

### BURNER - BOILER MOUNTING FLANGE

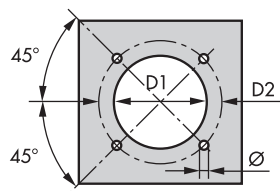

MODEL	D1	D2	Ø
RS 310/E-/EV MZ	335	452	M18
RS 410/E-/EV MZ	335	452	M18
RS 510/E-/EV MZ	335	452	M18
RS 610/E-/EV MZ	350	452	M18

### PACKAGING

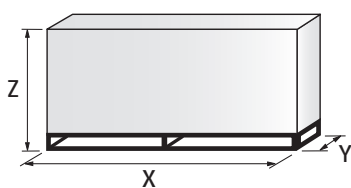

MODEL	X	Y	Z	kg
RS 310/E-/EV MZ	2040	1180	1125	250
RS 410/E-/EV MZ	2040	1180	1125	250
RS 510/E-/EV MZ	2040	1180	1125	250
RS 610/E-/EV MZ	2040	1180	1125	280



## Burner accessories

### Accessories for modulating operation

#### POWER CONTROLLER



To obtain modulating operation, the RS/E-/EV MZ series of burners requires a regulator with three point outlet controls. The following table lists the accessories for modulating operation with their application range.

BURNER	TYPE	CODE
All models	RWF 50.2 - Basic version with 3 position output	20073595
	RWF 55.5 - Complete with RS-485 interface	20074441
	RWF 55.6 - Complete with RS-485/PROFIBUS interface	20074442

#### PROBE



The relative temperature or pressure probes fitted to the power controller must be chosen on the basis of the application.

BURNER	TYPE	RANGE (°C) (bar)	CODE
All models	Temperature PT 100	-100 ÷ 500°C	3010110
	Pressure 4 ÷ 20 mA	0 ÷ 2,5 bar	3010213
	Pressure 4 ÷ 20 mA	0 ÷ 16 bar	3010214
	Pressure 4 ÷ 20 mA	0 ÷ 16 bar	3090873

#### CONTINUOUS VENTILATION KIT



If the burner requires continuous ventilation in the stages without flame, a special kit is available as given in the following table:

BURNER	CODE
RS 310-410-510-610/E MZ	20077810

#### OCI412 INTERFACE KIT



Interface kit between the REC 27.1 and a Modbus system, such as a building automation and control system (BACS). The Modbus interface is based on the RS-485 standard.

BURNER	CODE
RS 310-410-510-610/RS/E-/EV MZ	3010437

#### SPACER KIT

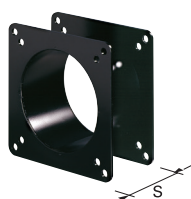

If burner head penetration into the combustion chamber needs reducing, varying thickness spacers are available, as given in the following table.

BURNER	SPACER THICKNESS S (mm)	CODE
All models	180	20008903

**VARIABLE SPEED DRIVE (VSD) FOR RS/EV MZ SERIES ONLY**



The motor speed variation for the RS/EV MZ burners series is obtained thanks to a frequency converter: variable speed drive (VSD) provided with a programming panel with start-up assistant.

BURNER	VOLTAGE	MOTOR POWER (kW)	INVERTER POWER (kW)	CODE
RS 310/EV MZ	230V	7.5	7.5	20083590
RS 310/EV MZ	400V	7.5	7.5	20028307
RS 410/EV MZ	230V	9.2	11	20083611
RS 410/EV MZ	400V	9.2	11	3090952
RS 510/EV MZ	400V	12	15	3090960
RS 610/EV MZ	400V	15	15	3090960

The use of inverters other than those indicated by the Manufacturer may lead to burner failure and, in extreme cases, a potential risk of harm to people and damage to property. The manufacturing company shall not be liable for any such damage arising from non-observance of the requirements contained in the burner manual.

**UV CELL KIT**



A UV cell is available for the supervision of the flame alternatively to ionisation probe for special applications.

BURNER	CODE
All models	20077814

**PC INTERFACE KIT**



To connect the control panel to a personal computer for the transmission of operation, fault signals and detailed service information, an interface adapter with PC software are available.

BURNER	CODE
All models (*)	3002719

(\*) Equipped with RMG/M control box

**SOUND PROOFING BOX**

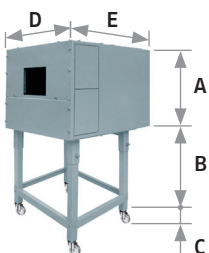

If noise emission needs reducing even further, sound-proofing boxes are available. In case of generator heights, where a lower dimension "B" is required, ask for the Box Support Kit code 20065135.

The useful dimensions are 40 mm less than the total dimensions indicated in the table (A, D, E). Not suitable for outdoor use.

BURNER	BOX TYPE	A (mm)	B (mm) min. - max.	C (mm)	D (mm)	E (mm)	[dB(A)] (*)	CODE
All models	C7	1255	160 - 980	110	1140	1345	10	3010376



(\*) Average noise reduction according to EN 15036-1 standard

## Gas train accessories

### ADAPTERS

In certain cases, an adapter must be fitted between the gas train and the burner, when the diameter of the gas train is different from the set diameter of the burner.

Below are given the available adapters; please see on the Gas Train list the correct adapter codes to select.

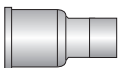
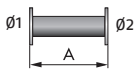
ADAPTER	DIMENSIONS				ADAPTER CODE
	Ø1 DN	Ø2 DN	A mm	B mm	
1" 1/2  2"	-	-	65	-	20064220
2"  2"	-	-	65	-	20042324
DN 80  2" 1/2  2"	-	-	300	-	3000826
	65	80	400	-	3010221
	80	80	400	-	3010222
	100	80	400	-	3010223
	125	80	320	-	3010224

### PVP (PRESSURE VALVE PROVING KIT)\*

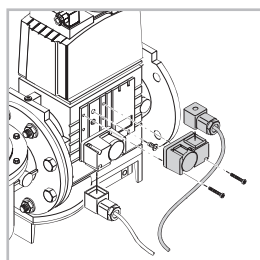

The seal control function is included on Burner Digital Management System, it is only necessary to add the PVP kit on the gas train.

The leak detection control is compulsory (EN 676) on the burner gas trains with a nominal output more than 1200 kW.

#### GAS TRAIN

MB - CB - DMV type

#### CODE

3010344

\* not necessary for those models where is included as a standard.

**STABILISER SPRING**

To vary the pressure range of the gas train stabilisers, accessory springs are available. The following table shows these accessories with their application range. Please refer to the technical manual for the correct choice of spring.

<b>GAS TRAIN</b>	<b>SPRING COLOUR</b>	<b>SPRING PRESSURE RANGE mbar</b>	<b>SPRING CODE</b>
MBC 1900/1 - 3100/1 MBC 5000/1	White	4 - 20	3010381
	Red	20 - 40	3010382
	Black	40 - 80	3010383
	Green	80 - 150	3010384
CB 512/1	Red	25 - 55	3010131
	Black	60 - 110	3010157
	Pink	90 - 150	3090486
CB 520/1 - 525/1	Red	25 - 55	3010132
	Black	60 - 110	3010158
	Pink	90 - 150	3090487
CB 5065/1 - 5080/1	Red	25 - 55	3010133
	Black	60 - 110	3010135
	Pink	100 - 150	3090456
	Grey	140 - 200	3090992
CB 50100/1	Red	25 - 55	3010134
	Black	60 - 110	3010136
	Pink	100 - 150	3090489
	Grey	140 - 200	3092174
CB 50125/1	Red	25 - 55	3010315
	Yellow	30 - 70	3010316
	Black	60 - 110	3010317
	Pink	100 - 150	3010318

# Specification

## DESIGNATION OF SERIES

A specific index guides your choice of burner from the various models available in the RS/E-/EV MZ series. Below is a clear and detailed specification description of the product.

Series: R											
Fuel: S Natural Gas											
L Light oil											
LS Light oil/Natural Gas											
N Heavy oil											
Size:											
Setting: /1 Single stage											
/B Two stage											
/M Modulating-Mechanical cam											
/E Electronic cam											
/P Proportioning air/gas valve											
/EV Electronic cam predisposed for variable speed (with inverter)											
/Evi Electronic cam with integrated inverter											
Emission: ... or C01 Class 1 EN267 - EN676											
MZ Class 2 EN267 - EN676											
BLU Class 3 EN267 - EN676											
MX Class 2 EN267											
Class 3 EN676											
Head length: TC standard head											
TL extended head											
Flame control system: FS1 Standard/Intermittent (at least 1 stop every 24 h)											
FS2 Continuous (1 stop every 72 h)											
Electrical supply to the system:											
1/230/50 1/230V/50Hz											
3/230/50 3/230V/50Hz											
3/400/50 3N/400V/50Hz											
3/230-400/50 3/230V/50Hz - 3N/400V/50Hz											
3/220/60 3/220V/60Hz											
3/380/60 3N/380V/60Hz											
3/220-380/60 3/220/60Hz - 3N/380V/60Hz											
Auxiliary voltage: 230/50-60 230V/50-60H											
110/50-60 110V/50-60Hz											
R	S	510	/E	MZ	TC	FS1	3/230-400/50	230/50-60			
BASIC DESIGNATION								EXTENDED DESIGNATION			

## AVAILABLE BURNER MODELS

BURNER MODELS				HEAT OUTPUT		TOTAL ELECTRICAL POWER (KW)	CERTIFICATION	NOTE
				NATURAL GAS				
				(KW)	(Nm <sup>3</sup> /h)			
RS 310/E MZ	TC	FS1	3/230/50	400/1200-3630	40/120-363	9,1	CE-0085C90166	
RS 310/E MZ	TC	FS1	3/400/50	400/1200-3630	40/120-363	9,1	CE-0085C90166	
RS 310/E MZ	TC	FS2	3/400/50	400/1200-3630	40/120-363	8,8	CE-0085C90166	(1)
RS 310/E MZ	TC	FS2	3/230/50	400/1200-3630	40/120-363	8,8	CE-0085C90166	
RS 310/E MZ	TC	FS2	3/400/50	400/1200-3630	40/120-363	9,1	CE-0085C90166	
RS 310/E MZ	TC	FS2	3/400/50	400/1200-3630	40/120-363	9,1	CE-0085C90166	(1)
RS 410/E MZ	TC	FS1	3/230/50	500/1500-4450	50/150-445	10,6	CE-0085C90166	
RS 410/E MZ	TC	FS1	3/400/50	500/1500-4450	50/150-445	10,6	CE-0085C90166	
RS 410/E MZ	TC	FS1	3/400/50	500/1500-4450	50/150-445	10,6	CE-0085C90166	(1)
RS 410/E MZ	TC	FS2	3/230/50	500/1500-4450	50/150-445	10,6	CE-0085C90166	
RS 410/E MZ	TC	FS2	3/400/50	500/1500-4450	50/150-445	10,6	CE-0085C90166	
RS 410/E MZ	TC	FS2	3/400/50	500/1500-4450	50/150-445	10,6	CE-0085C90166	(1)
RS 510/E MZ	TC	FS1	3/400/50	680/1800-5250	68/180-525	13,9	CE-0085C90166	(1)
RS 510/E MZ	TC	FS2	3/400/50	680/1800-5250	68/180-525	13,9	CE-0085C90166	(1)
RS 610/E MZ	TC	FS1	3/400/50	1000/2200-6250	100/220-625	16,9	CE-0085C90166	(1)
RS 610/E MZ	TC	FS2	3/400/50	1000/2200-6250	100/220-625	16,9	CE-0085C90166	(1)
RS 310/EV MZ	TC	FS1/FS2	3/230/50	400/1200-3630	40/120-363	9,1	In progress	
RS 310/EV MZ	TC	FS1/FS2	3/400/50	400/1200-3630	40/120-363	9,1	In progress	
RS 410/EV MZ	TC	FS1/FS2	3/230/50	500/1500-4450	50/150-445	10,8	In progress	
RS 410/EV MZ	TC	FS1/FS2	3/400/50	500/1500-4450	50/150-445	10,8	In progress	
RS 510/EV MZ	TC	FS1/FS2	3/400/50	680/1800-5250	68/180-525	14	In progress	
RS 610/EV MZ	TC	FS1/FS2	3/400/50	1000/2200-6250	100/220-625	17	In progress	

Natural gas, net calorific value: 10 kWh/Nm<sup>3</sup> - Density: 0,71 kg/Nm<sup>3</sup>

The burners of RS/E-/EV MZ series are in according to 2009/142/EC - 2014/30/UE - 2014/35/UE - 2006/42/EC Directives.

(1) Star delta starter.

## SPECIFICATION

### STATE OF SUPPLY

Monoblock forced draught burners with two stage progressive or modulating operation, with a specific kit, fully automatic, made up of:

- Microprocessor-based Digital Burner Management System (RS/E MZ models)
- Microprocessor-based Digital Burner Management System with Variable Speed Drive technology for the control of a Frequency Inverter (RS/EV MZ models)
- Display Interface operating unit to adjust the system
- Air suction circuit lined with sound-proofing material
- High performance fan with low sound emissions, forward curve blades
- Air damper for air flow setting and butterfly valve for regulating fuel output controlled by independent stepper motor actuators
- Air pressure switch
- Fan starting motor at 2900 rpm, three-phase 230/400 - 400/690 V with neutral, 50 Hz
- Combustion head, that can be set on the basis of required output, fitted with:
  - stainless steel end cone, resistant to corrosion and high temperatures
  - ignition electrodes; ionisation sensor for flame detection (or UV sensor on demand)
  - flame stability disk
- Maximum gas pressure switch, with pressure test point, for halting the burner in the case of over pressure on the fuel supply line
- Star/delta starter for the fan motor (Direct starter fan motor for RS 310-410 models)
- Main electrical supply terminal board
- Burner on/off switch
- Manual or automatic output increase/decrease switch
- Contacts motor and thermal relay with release button
- Burner failure led signal and lighted release button
- Burner opening hinge
- Lifting rings
- IP 54 electric protection level

### Standard equipment:

Gasket for gas train adaptor

Adaptor for gas train

Screws for fixing the gas train adaptor: M 16 x 70

Thermal insulation screen

M 18 x 60 screws to secure the burner flange to the boiler

Cable grommets kit for optional electrical wiring input

M16 x 6 studs for fixing the gas elbow to the pipe coupling

M16 nuts to fix the gas elbow to the pipe coupling

Instruction handbook for installation, use and maintenance

Spare parts catalogue

### Conforming to:

- 2014/30/UE directive (electromagnetic compatibility)
- 2014/35/UE directive (low voltage)
- 2009/142/EC directive (gas)
- 2006/42/EC directive (machine)
- EN 676 (gas burners).

# Riello Burners a world of experience in every burner we sell.

11/2016

TS0102UK01



[ 1 ]

Across the world, Riello sets the standard in reliable and high efficiency burner technology.

With burner capacity from 5 kW to 48 MW, Riello gas, oil, dual fuel and Low Nox burners deliver unbeatable performance across the full range of residential and commercial heating applications, as well as in industrial processes.

With headquarter in Legnago, Italy, Riello has been manufacturing premium quality burners for over 90 year. The manufacturing plant is equipped with the most innovative systems of assembling lines and modern manufacturing cells for a quick and flexible response to the market.



[ 2 ]

Besides, the Riello Combustion Research Centre, located in Angiari, Italy, represents one of the most modern facility in Europe and one of the most advanced in the world for the development of the combustion technology.

Today, the company's presence on worldwide markets is distinguished by a well-constructed and efficient sales network, alongside many important Training Centres located in various countries to meet its customers' needs. Riello has 13 operational branches abroad (in Europe, America and Asia), with customers in over 60 countries.

[ 1 ] BURNERS PRODUCTION PLANT  
S. PIETRO, LEGNAGO (VERONA) - ITALIA

[ 2 ] HEADQUARTER BURNERS DIVISION  
S. PIETRO, LEGNAGO (VERONA) - ITALIA

RIELLO S.p.A. - 37045 Legnago (VR) - Italy  
tel. +39 0442 630111 - fax: +39 0442 21980  
[www.riello.com](http://www.riello.com)

Since the Company is constantly engaged in the production improvement, the aesthetic and dimensional features, the technical data, the equipment and the accessories can be changed. This document contains confidential and proprietary information of RIELLO S.p.A. Unless authorised, this information shall not be divulged, nor duplicated in whole or in part.

# RIELLO